

EX8000-6

SALES BROCHURE

EX8000



BUCKET CAPACITY:
BACKHOE (SAE) (HEAPED): 43.0 m³ (56.2 cu. yd.)
SHOVEL (HEAPED): 40.0 m³ (52.3 cu. yd.)

OPERATING WEIGHT:
BACKHOE: 837 000 kg (1,845,269 lb.)
SHOVEL: 825 000 kg (1,818,814 lb.)

RATED POWER:
2 x 1450 kW (2 x 1,944 hp)

EXCAVATOR FOCUSED. NO DISTRACTIONS.

WORLD-CLASS MINING EXCAVATORS.

At Hitachi, we don't get sidetracked building every kind of construction and mining equipment. Instead, we focus on trucks and excavators. It's that focus, combined with our technological expertise, that gives you efficient, reliable and durable machines.

It's no coincidence that over one-third of all hydraulic mining excavators working across the world are Hitachi. All of our excavators, like the EX8000-6, are engineered to give you the flexibility to handle all kinds of jobs. You get strong horsepower, efficient engines, comfortable cabs, advanced hydraulics, tough frames and powerful arm- and bucket-digging forces.

It all adds up to more productivity and more...

VALUE FOR YOUR HARD-EARNED DOLLAR.



SPECIALISTS



PRODUCTIVITY



Bucket Passes to Dump Trucks										
	Truck	Nominal Payload	Bucket Capacity	Passes to Fill						
				1	2	3	4	5	6	7
Shovel	EH4000AC-3	222 tonnes (245 tons)	40-m ³ (52.3 cu. yd.) Bucket							
	EH5000AC-3	296 tonnes (326 tons)	40-m ³ (52.3 cu. yd.) Bucket							
Backhoe	EH4000AC-3	222 tonnes (245 tons)	43-m ³ (56.2 cu. yd.) Bucket							
	EH5000AC-3	296 tonnes (326 tons)	43-m ³ (56.2 cu. yd.) Bucket							



WORK ANYWHERE, **ANYTIME.**

SUPERSIZE PRODUCTION.

Tough job? Bring it on. No job is too big for the EX8000-6, our largest excavator. Fuel-efficient, twin Cummins QSK60C engines provide powerful performance with an Engine-Pump Control (E-P Control) system that efficiently adjusts power to your load demand. The advanced hydraulic system tops the industry for smooth, combined bucket-tilt, boom-raise and fast pass speeds, which delivers quicker loading times. Additionally, you get a stronger boom and bigger bucket for increased lift capacity. The EX8000-6 pairs well with the EH4000AC-3 and EH5000AC-3 Trucks, and is available in backhoe and front-shovel configurations. Add the EX8000-6 to your fleet, and you get...

BIG-TIME PRODUCTIVITY.

■ **Flow-Assisting Circuit.**

Using the meter-in valves, ample-capacity make-up valves and flow-assisting pumps, the flow speed is increased in cylinders for dynamic actions, like between dumping and digging.

■ **Efficient E-P Control.**

The computer-aided Engine-Pump Control (E-P Control) system senses load demand and adjusts power to the work being performed.

■ **Powerful Engines.**

Tackle any job with twin Cummins QSK60C diesel engines that meet U.S. EPA Tier 2 emission regulations.

TOUGH ENOUGH FOR YOUR TOUGHEST JOBS.

ROCK-SOLID RELIABILITY.

Tough jobs demand extremely durable excavators. And the EX8000-6 is designed and built with strength you can count on. Toughness is built-in with the rigid box design; cast steel, center track frame; rugged lower rollers; track links and drive tumblers. Constant correct track tension reduces damage and downtime. Flow-retarding control for arm/bucket roll-in and roll-out at cylinder stroke ends improves controllability and helps extend service life. Strategically positioned oil coolers and high-pressure filters simplifies maintenance to give you more uptime. Add it all up, and the EX8000-6 is...

BUILT TO PERFORM, BUILT TO LAST.

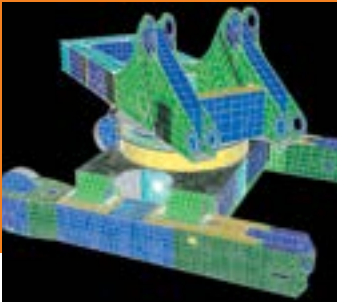

■ The rigid box design resists bending and twisting forces, giving you stability and strength on any job.



■ Rugged lower rollers, track shoes and drive tumblers sustain the giant body for increased durability.



■ The cast steel, center track frame can avoid stress concentration and increase reliability.



DURABILITY



■ With constant correct track tension, travel is automatically stopped if the nitrogen gas accumulator pressure exceeds a preset level. Alert information and countermeasures are indicated on the multi-display LCD monitor.

■ Flow-retarding control at cylinder stroke ends improves controllability and helps extend service life. This mechanism is provided for arm/bucket roll-in and roll-out.

■ Three oil coolers are strategically positioned far from the engine radiator for even better cooling potential.

■ High-pressure filters are located down-line from the pumps for easy maintenance.



COMFORT

■ The sturdy cab protects operators from falling objects. The cab's top guard meets OPG Level II (ISO) standards. The entire cab sits on a package of fluid-filled elastic mounts that absorb vibration for a more comfortable ride.

■ The high-visibility, nine-meter (29 ft. 6 in.) cab height provides a clear view of the work site – even when loading the largest trucks.

■ The air-suspension, multi-position seat can be customized to the operator's needs and seat can be adjusted to accommodate the operator's weight and personal preference.

■ The well-insulated, pressurized cab keeps out dust and is air conditioned.

COMFORT BUILT IN. DOWNTIME TOSSED OUT.

SAFE AND EFFICIENT CABS.

As excavator experts, we've designed the EX8000-6 cab to keep operators as comfortable, efficient and productive as possible. The well-insulated, pressurized cab keeps dust out while maintaining a comfortable temperature thanks to a highly efficient heating/air conditioning system. Operators of all sizes have plenty of legroom and storage space with the cab's ergonomic design, which helps operators stay productive even on long work shifts. With the EX8000-6, you get...

MORE COMFORT, MORE PRODUCTIVITY.

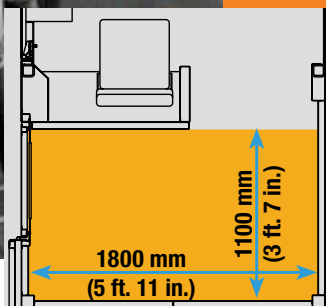

Plenty of utility space located behind the operator seat allows for 24-hour operation. The space can accommodate a table, electric oven and refrigerator.



Electric joystick control levers provide precise and almost effortless operation.



The multi-display LCD monitor provides machine data, operating status and alerts at a glance. The monitor can be preset to indicate replacement intervals for engine oil, hydraulic oil and filters.



Four optional outside cameras can be mounted around the machine for enhanced visibility – virtually eliminating blind spots.

MINIMAL MAINTENANCE, MAXIMUM PERFORMANCE.

REDUCE DOWNTIME, SAVE MONEY.

As our biggest excavator, the EX8000-6 provides big advantages when it comes to easy, quick maintenance. Simple servicing, inspection and cleaning reduces costs and lets you get back to work faster. This excavator is loaded with time- and money-saving maintenance features like easy-to-check sight gauges and fluid reservoirs, quick-change remote-mounted filters, advanced self-diagnostics and extended filter replacement intervals. When you're operating an EX8000-6, you always get...

EASY, COST-SAVING MAINTENANCE.



■ Folding stairs with wide steps allow for easy accessibility, servicing and maintenance.



■ Convenient Centralized Filter System designed to make filter inspection and maintenance easier.



■ The auto-lubrication system for the front joint pins and swing circle saves service time.



■ A contamination sensor alerts the operator of accumulated contaminants in the oil before damage might occur.



COST-SAVING



■ Ejectors automatically expel dust from the air cleaners, giving you one less routine-maintenance task.

■ A protective steel barrier between the engine and pump bulkhead contributes to lower heat and less potential for damage.

EX8000-6

MINING EXCAVATOR



SUPPORT

FOCUSED ON YOU, NO DISTRACTIONS.

SUPPORTING YOUR BOTTOM LINE.

It can be frustrating when you need service or parts – especially when you can't get them quickly because the manufacturer is distracted dealing with all kinds of other equipment customers.

At Hitachi, we concentrate on excavators and trucks. So you can count on us to respond rapidly. You'll get the parts you need, the service you want and the customer support you deserve. We stand behind you with a strong dealer network; a skilled factory support team; trained mechanics; and one of the best, most comprehensive warranty and maintenance programs available. Because we're focused on you, you get...

WHAT YOU NEED, WHEN YOU NEED IT.

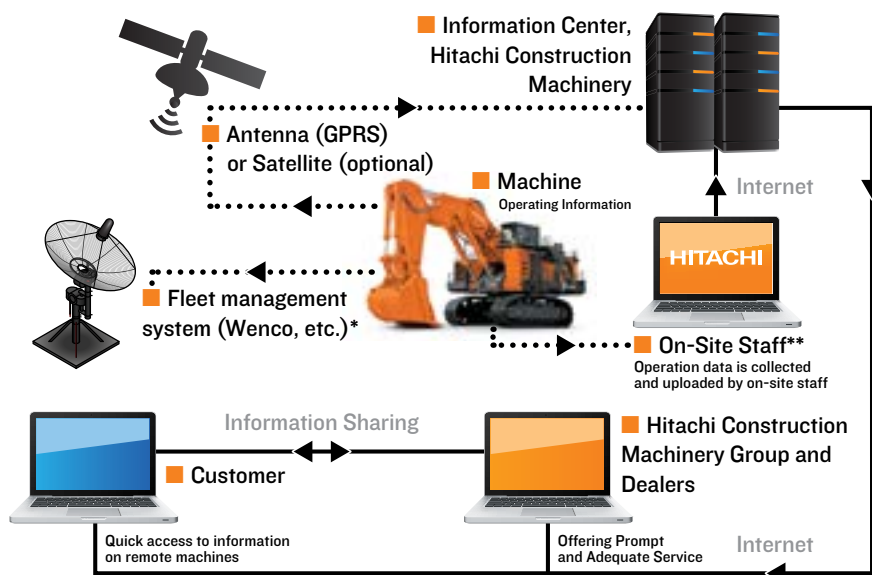

Remote Machine Management with Global e-Service.
This online machine management system allows you to access each on-site machine from a PC in your office. You can get its operating information and location to increase productivity. Operating data and log are sent to a Hitachi server for processing, and then to customer and dealers. This system is available 24/7/365.

Note: In some regions, the Satellite Communication Device is not available by local regulations; the GPRS (mobile) communication device is an option for these regions.

* DTU (Data Transfer Unit) (optional) is required for connection to fleet management systems.

**WIU (Wireless Interface Unit) transmits operating data via wireless connection for downloading data.

EX8000-6 SPECS

MINING EXCAVATOR

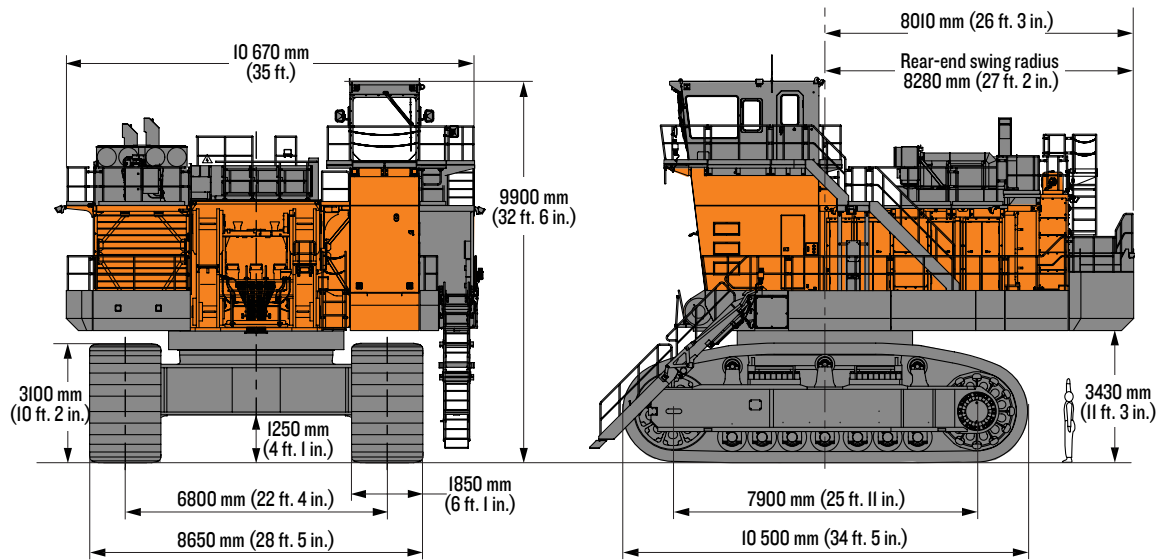

ILLUSTRATIONS SHOW DIESEL ENGINE MACHINE

Engine		EX8000-6		Electric Motor		EX8000E-6	
Manufacturer and Model	Cummins QSKTA60-CE	Manufacturer and Model	HITACHI TFOA-KK	Manufacturer and Model	HITACHI TFOA-KK	Manufacturer and Model	HITACHI TFOA-KK
Type	4 cycle	Type	High voltage, three-phase, squirrel cage induction motor, totally enclosed air-to-air-cooled (TEAAC).	Type	High voltage, three-phase, squirrel cage induction motor, totally enclosed air-to-air-cooled (TEAAC).	Type	High voltage, three-phase, squirrel cage induction motor, totally enclosed air-to-air-cooled (TEAAC).
Aspiration	Water-cooled, 16-cylinder, turbocharged and aftercooled, direct-injection chamber-type diesel engine	Rating		Rating		Rating	
Emission certification	U.S.EPA Tier 2	Rated continuous output	1200 kW x 2	Rated continuous output	1200 kW x 2	Rated continuous output	1200 kW x 2
Rated power		Voltage	AC 6000 - 6600 V / 50 Hz AC 6600 - 6900 V / 60 Hz	Voltage	AC 6000 - 6600 V / 50 Hz AC 6600 - 6900 V / 60 Hz	Voltage	AC 6000 - 6600 V / 50 Hz AC 6600 - 6900 V / 60 Hz
Gross (SAE J1995)	2 x 1450 kW (2 x 1,944 hp) @ 1800 min ⁻¹ (rpm)	Number of poles	4	Number of poles	4	Number of poles	4
Net	2 x 1450 kW (2 x 1,944 hp) @ 1800 min ⁻¹ (rpm)	Synchronous RPM	1500 min ⁻¹ / 50 Hz 1800 min ⁻¹ / 60 Hz	Synchronous RPM	1500 min ⁻¹ / 50 Hz 1800 min ⁻¹ / 60 Hz	Synchronous RPM	1500 min ⁻¹ / 50 Hz 1800 min ⁻¹ / 60 Hz
Maximum torque	2 x 8364 Nm (2 x 853 kgf-m) @ 1500 min ⁻¹ (rpm)	Rated current	124 A x 2 @ 6600 V	Rated current	124 A x 2 @ 6600 V	Rated current	124 A x 2 @ 6600 V
Piston displacement	2 x 60L (3,661 cu. in.)	Insulation class	F class B raise	Insulation class	F class B raise	Insulation class	F class B raise
Bore and stroke	159 mm x 190 mm (6.3 in. x 7.5 in.)	Space heater included		Space heater included		Space heater included	
Starting system	24 V electric motor	Thermo-guard (temperature detector)		Thermo-guard (temperature detector)		Thermo-guard (temperature detector)	
Batteries	8 x 12 V, 8 x 220 AH	Starting condition	Reactor 50% tap	Starting condition	Reactor 50% tap	Starting condition	Reactor 50% tap
Cold starting	Ether aided						

Hydraulic System

Hitachi's ETS (Electronic Total control System) can achieve maximum job efficiency by reducing fuel consumption and noise levels, while maximizing productivity through the optimization of engine-pump functions with excellent controllability increasing operator comfort.

Computer-Aided Engine-Pump Control System (E-P Control)

Main pumps regulated by electric engine speed sensing control system. Optimum operation mode selectable among 3 power modes depending on type of job.

Integrated Optimum

Hydraulic System (I-OHS)

LD:16 main pumps, 6 control valves and 2 sets of flow-assisting valves enable both independent and combined operations of all functions

BH:16 main pumps and 8 control valves

Additional Features

Fuel-saving Pump System (FPS) minimizes energy loss with superior performance in fine control

Auto-idle system saves fuel and reduces noise

Hydraulic drive cooling-fan system for oil cooler

Hydraulic drive cooling-fan system for radiator

Forced-lubrication and forced-cooling pump drive system

Main Pumps

16 variable-displacement, axial piston pumps for front attachment, travel and swing

Maximum oil flow 16 x 500 L/min (16 x 132.1 gal./min.)

Pilot Pump

Gear pump (2)

Maximum oil flow 2 x 110 L/min (2 x 29.06 gal./min.)

Relief Valve Settings

Implement circuit 29.4 MPa (300 kgf/cm²) (4,264 psi)

Travel circuit 29.4 MPa (300 kgf/cm²) (4,264 psi)

Swing circuit 29.4 MPa (300 kgf/cm²) (4,264 psi)

Pilot circuit 4.4 MPa (45 kgf/cm²) (640 psi)

Hydraulic Cylinders

High-strength piston rods and tubes adopted. Cylinder cushion mechanisms are provided for boom, arm, bucket, and dump cylinders.

Bucket cylinders of loading shovel are provided with protector.

SPECS

Cylinder Dimensions (Backhoe)		EX8000-6	
	Quantity	Bore	Rod Diameter
Boom	2	480 mm (18.9 in.)	340 mm (13.4 in.)
Arm	2	420 mm (16.5 in.)	300 mm (11.8 in.)
Bucket	2	360 mm (14.2 in.)	260 mm (10.2 in.)

Cylinder Dimensions (Loading Shovel)		EX8000-6	
	Quantity	Bore	Rod Diameter
Boom	2	480 mm (18.9 in.)	340 mm (13.4 in.)
Arm	2	390 mm (15.4 in.)	270 mm (10.6 in.)
Bucket	2	390 mm (15.4 in.)	270 mm (10.6 in.)
Dump	2	310 mm (12.2 in.)	180 mm (07.0 in.)

Hydraulic Filters

All hydraulic circuits have high-quality hydraulic filters for protection against oil contamination and longer life of hydraulic components. Filters are centralized for convenient maintenance.

	Quantity	
Full-flow filter	10	10 µm
High-pressure strainer (in main and swing pump line)	16	80 meshes
Drain filter (for all plunger-type pumps and motors)	1	10 µm
Bypass filter (in oil cooler by-pass line)	1	5 µm
Pilot filter	2	10 µm

Controls

Two Implement Levers

Electric joystick control levers. Right lever is for boom and bucket control, left lever for swing and arm control.

Two pedals provided for opening/closing the bottom dump bucket.

Two Travel Levers with Pedals

Remote-controlled hydraulic servo system. Independent drive at each track allows counter rotation of tracks.

- 1 Left Console
- 2 Left Control Lever/Horn Switch
- 3 Left Travel Pedal
- 4 Left Travel Lever
- 5 Right Travel Lever
- 6 Right Travel Pedal
- 7 Right Control Lever/Horn Switch
- 8 Right Console
- 9 Operator's Seat
- 10 Bucket Close Pedal (for loading shovel)
- 11 Bucket Open Pedal (for loading shovel)
- 12 Pilot Control Shut-Off Lever
- 13 Rear Console
- 14 Emergency Engine Stop Switch
- 15 Engine Speed Control Dial
- 16 Key Switch
- 17 Monitor Display

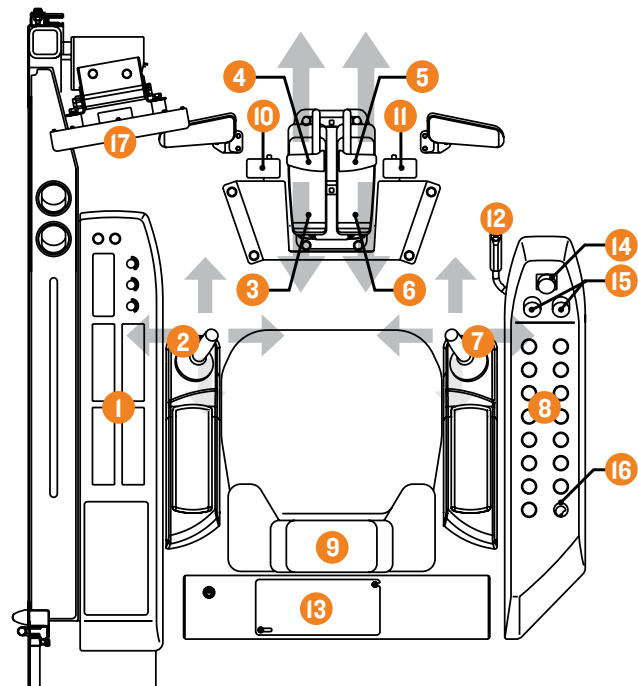

DIESEL ENGINE CONTROLS

Upperstructure

EX8000-6

Revolving Frame

Deep, full-reinforced box section. Heavy-gauge steel plates used for ruggedness.

Deck Machinery

Maintenance accessibility is the major feature in the layout of deck machinery. Folding stairs provide easy access to the deck machinery. And also the side walk provides easy access to motors, hydraulic and electrical components.

- 1 Engine x 2
- 2 Engine Radiator x 4
- 3 LTA Radiator x 4
- 4 Hydraulic Pump x 16
- 5 Engine-Pump Bulkhead x 2
- 6 Hydraulic Oil Tank
- 7 Fuel Tank
- 8 Control Valve x 6
- 9 High-Pressure Strainer x 16
- 10 Hydraulic Oil Cooler x 6
- 11 Hydraulic Oil Cooling Fan Motor x 3
- 12 Lubricator
- 13 Swing Device x 6
- 14 Center Joint
- 15 Cab
- 16 Air Filter x 4
- 17 Muffler x 4
- 18 Folding Stairs
- 19 Fan Motor x 8
- 20 Battery Unit
- 21 Reserve Tank (engine oil) x 2
- 22 Reserve Tank (coolant) x 2
- 23 Pump Mission Oil Cooler x 2
- 24 Fuel Cooler x 2
- 25 Engine Room Cooling Fan x 2

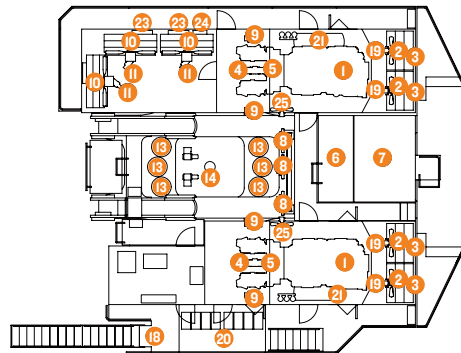
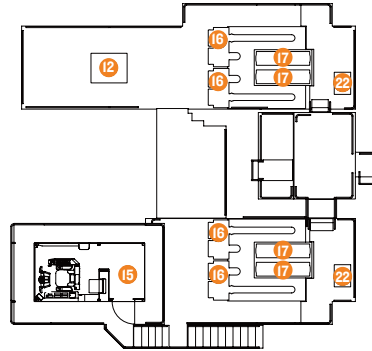

DECK MACHINERY FOR DIESEL ENGINE MACHINE

Upperstructure

EX8000E-6

Revolving Frame

Deep, full-reinforced box section. Heavy-gauge steel plates used for ruggedness.

Deck Machinery

Maintenance accessibility is the major feature in the layout of deck machinery. Folding stairs provide easy access to the deck machinery. And also the side walk provides easy access to motors, hydraulic and electrical components.

- 1 Main Motor x 2
- 2 Coupler x 2
- 3 Pump Drive Unit x 2
- 4 Hydraulic Pump x 16
- 5 Hydraulic Oil Cooling Fan Motor x 3
- 6 Hydraulic Oil Cooler x 2 x 3
- 7 Lubricator
- 8 Pump Transmission Oil Cooler x 2
- 9 Motor-Pump Bulkhead x 2
- 10 Bulkhead x 2
- 11 Hydraulic Oil Tank
- 12 Cubicle
- 13 Control Valve x 6
- 14 Swing Device x 6
- 15 Slip Ring
- 16 Center Joint
- 17 High-Pressure Strainer x 16
- 18 Battery x 2
- 19 Cab
- 20 Folding Stairs
- 21 Cab Heater Unit

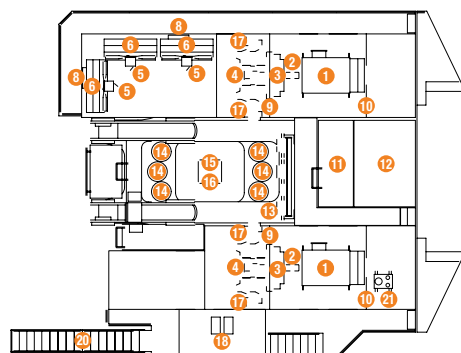
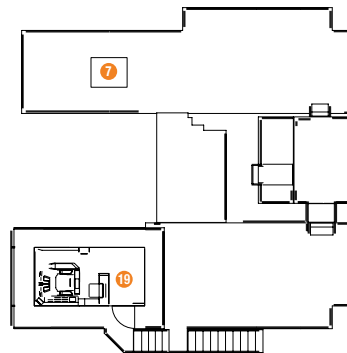

DECK MACHINERY FOR ELECTRIC MOTOR MACHINE

SPECS

Swing Device **EX8000-6**

6 high-torque, axial-piston motors with 2-stage planetary gear bathed in oil. Swing circle with dirt seals is a heavy-duty, triple-row, cylindrical roller bearing. Induction-hardened internal swing circle gear and pinion immersed in lubricant. Parking brake of springset/hydraulic-released disc type. This parking brake is manually releasable.

Swing speed 3.2 min⁻¹ (rpm)

Operator's Cab

The sturdy cab, with the top guard conforming to OPG Level II (ISO), helps protect the operator from falling objects. 1800 mm (5 ft. 11 in.) width, 3360 mm (11 ft.) length, 2150 mm (7 ft. 1 in.) height, roomy cab with tinted-glass windows features all-around visibility. Multi-display [267-mm (10.5 in.) LCD] for centralized information of machine status. Color monitor cameras for rear, right side and left lower views. Three separate pressurized air-conditioning systems.

Noise level 75 dB(A) in the cab at maximum engine speed under no-load condition

Eye-level height 9000 mm (29 ft. 6 in.)

Undercarriage

Tracks

Shovel-type undercarriage. Dual-flanged-type bolt linkage for side frame and X-form center frame ensures durability. Heavy-duty track frame of all-welded, stress-relieved structure. Top-grade materials used for toughness. Lifetime-lubricated induction-hardened track rollers, idlers and drive tumblers with floating seals. Specially heat-treated connection pins. Hydraulic track adjuster provided with N2 gas accumulator with relief valve. Track adjuster provided with protection device against abnormal tension. Travel motion alarm device.

Shovel-Type Undercarriage

Triple grouser shoes specially heat treated cast steel

Shoe width 1850 mm (6 ft. 1 in.)

Number of Rollers and Shoes (each side)

Upper rollers 3

Lower rollers 7

Track shoes 39

Travel Device

Each track driven by high-torque, axial piston motors, allowing counter rotation of tracks. 2-stage planetary gear plus spur gears reduction device. Dual-support-type traction device. Parking brake of springset/hydraulic-released disc type. This parking brake can be manually releasable.

Travel speeds High: 0 – 2.0 km/h (0 – 1.2 mph)

Low: 0 – 1.4 km/h (0 – 0.9 mph)

Maximum traction force 3000 kN / 305 914 kgf (674,425 lbf.)

Gradeability 58% (30°) maximum

Weights and Ground Pressure

Loading Shovel

Equipped with 40-m³ (52.3 cu. yd.) (SAE heaped 2:1) bottom-dump bucket.

Diesel Engine

Shoe Type	Shoe Width	Operating Weight	Ground Pressure
Triple Grousers	1850 mm (72 in.)	825 000 kg (1,818,814 lb.)	248 kPa (2.53 kgf/cm ²) (36 psi)

Electric Motor

Shoe Type	Shoe Width	Operating Weight	Ground Pressure
Triple Grousers	1850 mm (72 in.)	808 000 kg (1,781,335 lb.)	243 kPa (2.48 kgf/cm ²) (35.2 psi)

Backhoe

Equipped with 11.5-m (37 ft. 9 in.) boom, 5.8-m (19 ft.) arm, and 43-m³ (56.2 cu. yd.) (SAE heaped 1:1) bucket.

Diesel Engine

Shoe Type	Shoe Width	Operating Weight	Ground Pressure
Triple Grousers	1850 mm (72 in.)	837 000 kg (1,845,269 lb.)	252 kPa (2.57 kgf/cm ²) (36.5 psi)

Electric Motor

Shoe Type	Shoe Width	Operating Weight	Ground Pressure
Triple Grousers	1850 mm (72 in.)	820 000 kg (1,807,791 lb.)	247 kPa (2.52 kgf/cm ²) (35.8 psi)

Service Refill Capacities

	Diesel Powered	Electric Powered
Fuel tank	14 900 L (3,936.2 gal.)	
Engine coolant	2 x 614 L (162.2 gal.)	
Engine oil		
Engine oil pan	2 x 260 L (68.7 gal.)	
Reserve tank	2 x 280 L (74 gal.)	
Pump transmission device	2 x 62 L (16.4 gal.)	2 x 62 L (16.4 gal.)
Swing device	6 x 75 L (19.8 gal.)	6 x 75 L (19.8 gal.)
Travel device	2 x 490 L (129.4 gal.)	2 x 490 L (129.4 gal.)
Hydraulic system	9700 L (2,562.5 gal.)	9700 L (2,562.5 gal.)
Hydraulic oil tank	3890 L (1,027.6 gal.)	3890 L (1,027.6 gal.)

EX8000-6 SPECS

MINING EXCAVATOR

Loading Shovel Attachment

EX8000-6

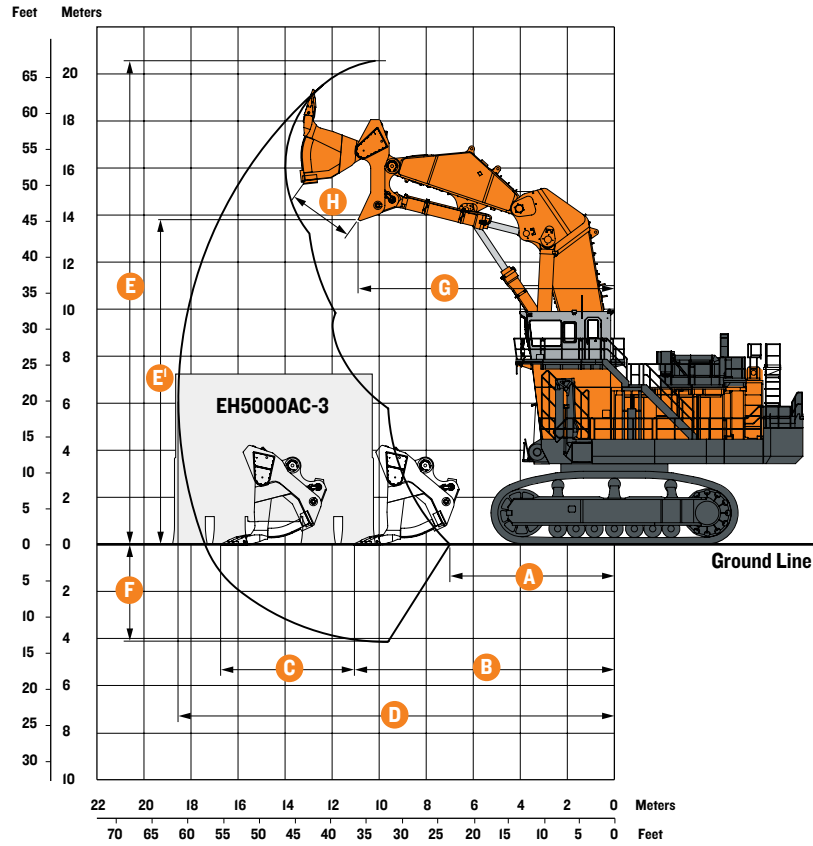

Working Ranges

Bucket Capacity (Heaped)	40.0 m³ (52 cu. yd.)
A Min digging distance	7200 mm (23 ft. 7 in.)
B Min level crowding distance	11 100 mm (36 ft. 5 in.)
C Level crowding distance	5600 mm (18 ft. 4 in.)
D Max digging reach	18 500 mm (60 ft. 8 in.)
E Max cutting height	20 500 mm (68 ft. 3 in.)
E' Max dumping height	13 800 mm (45 ft. 3 in.)
F Max digging depth	4100 mm (13 ft. 5 in.)
G Working radius at max dumping height	10 900 mm (35 ft. 9 in.)
H Max bucket opening width	2800 mm (9 ft. 2 in.)
Bucket digging force	2230 kN / 227 396 kgf (501,322 lbf.)
Arm crowding force	2870 kN / 292 658 kgf (645,200 lbf.)

Bucket

Boom and arm are of all-welded, low-stress, high-tensile strength steel full-box section design.

Capacity (heaped)	Width	Number of Teeth	Weight	Type
40.0 m ³ (52.3 cu. yd.)	5600 mm (18 ft. 4 in.)	6	62 500 kg (137,789 lb.)	Bottom-dump-type general purpose

Note: These buckets do not include any type of wear protection for sides, bottom, and inside the bucket. Please consult your local Hitachi dealer for a proper wear protection system for your application. Please do not use the buckets without proper wear protection for your application.

SPECS

Backhoe Attachment

EX8000-6

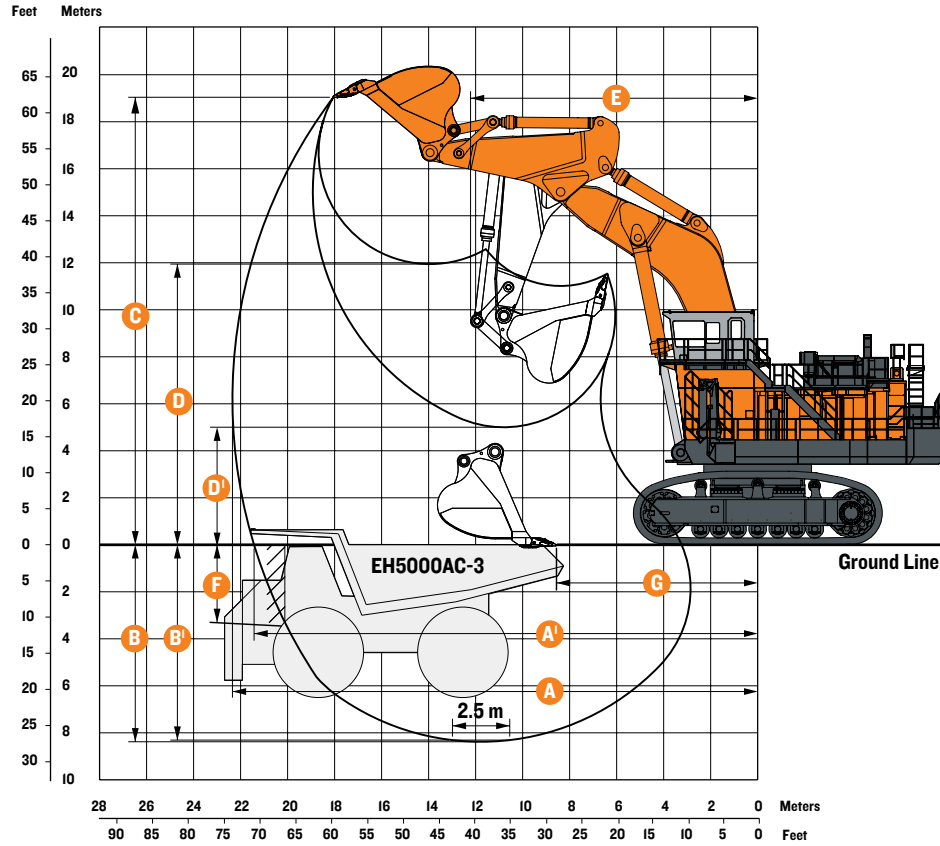

Working Ranges

BE-boom length		11.5 m (37 ft. 9 in.)
BE-arm length		5.8 m (19 ft.)
A Max digging reach		22 300 mm (73 ft. 2 in.)
A' Max digging reach (on ground)		21 400 mm (70 ft. 3 in.)
B Max digging depth		8400 mm (27 ft. 7 in.)
B' Max digging depth (2.5 m level)		8300 mm (27 ft. 3 in.)
C Max cutting height		19 000 mm (62 ft. 4 in.)
D Max dumping height		11 900 mm (39 ft.)
D' Min dumping height		5000 mm (16 ft. 5 in.)
E Min swing radius		12 200 mm (40 ft.)
F Max vertical wall		3300 mm (10 ft. 10 in.)
G Min level crowding distance		8600 mm (28 ft. 3 in.)
Bucket digging force	SAE	1900 kN / 193 746 kgf (427,136 lbf.)
	ISO	2020 kN / 205 982 kgf (454,112 lbf.)
Arm crowding force	SAE	1750 kN / 178 450 kgf (393,414 lbf.)
	ISO	1770 kN / 180 489 kgf (397,910 lbf.)

Bucket

Boom and arm are of all-welded, low-stress, full-box section design. Bucket of all-welded, high-strength steel structure. Bucket/arm and arm/boom joint pins are floating type.

Replaceable thrust plates are provided with bucket/arm joint part. Auto-lubrication system for all pins is standard.

Capacity (heaped)	Width (with side cutters)	Number of Teeth	Weight	Type	Materials density
43.0 m ³ (56.2 cu. yd.)	4850 mm (15 ft. 11 in.)	6	44 200 kg (97,444 lb.)	General purpose	1800 kg/m ³ (3,034 lb./cu. yd.) or less

Note: These buckets do not include any type of wear protection for sides, bottom, and inside the bucket. Please consult your local Hitachi dealer for a proper wear protection system for your application. Please do not use the buckets without proper wear protection for your application.

TRANSPORTATION

Upperstructure

EX8000-6

CAB ASSEMBLY

Weight: 3690 kg (8,135 lb.)
Width: 1820 mm (6 ft.)

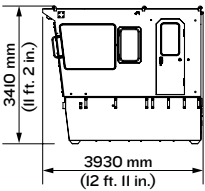

INTAKE/EXHAUST DEVICE

Weight: 1630 kg (3,594 lb.)
Width: 2580 mm (8 ft. 6 in.)

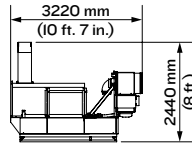

WATER TANK

Weight: 120 kg (265 lb.)
Width: 913 mm (3 ft.)

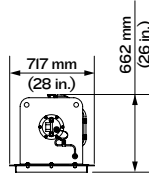

ENGINE UNIT (LEFT)

Weight: 36 600 kg (80,689 lb.)
Width: 2810 mm (9 ft. 3 in.)

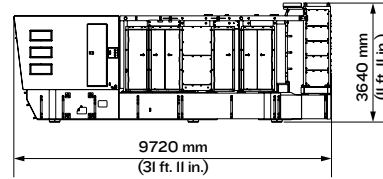

BATTERY BOX

Weight: 1280 kg (2,822 lb.)
Width: 1480 mm (4 ft. 10 in.)

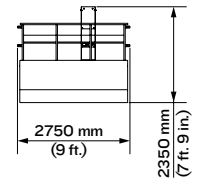

MAIN FRAME ASSEMBLY

Weight: 56 000 kg (123,459 lb.)
Width: 4000 mm (13 ft. 2 in.)

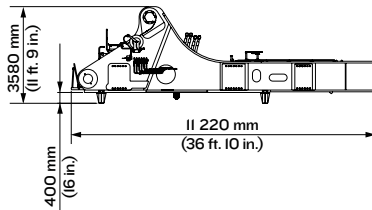

VALVE ASSEMBLY

Weight: 5380 kg (11,861 lb.)
Width: 3160 mm (10 ft. 4 in.)

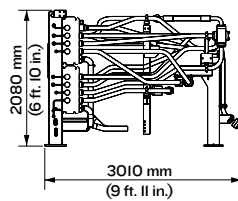

SWING DEVICE

Weight: 1660 kg (3,660 lb.) x 6
Width: 1300 mm (4 ft. 3 in.)

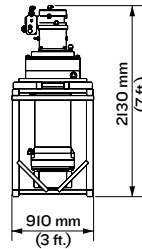

OIL TANK ASSEMBLY

Weight: 9920 kg (21,870 lb.)
Width: 1410 mm (4 ft. 8 in.)

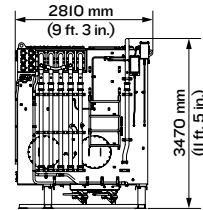

FUEL TANK ASSEMBLY

Weight: 5620 kg (12,390 lb.)
Width: 2180 mm (7 ft. 2 in.)

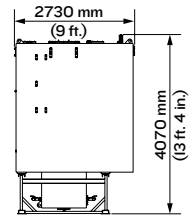

SPECS

TRANSPORTATION

Upperstructure (continued)

EX8000-6

HYDRAULIC-OIL SUCTION DEVICE

Weight: 42 kg (93 lb.)
Width: 495 mm (19 in.)

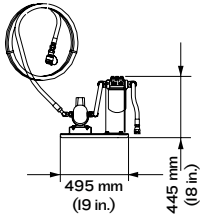

ENGINE UNIT (RIGHT)

Weight: 42 700 kg (94,137 lb.)
Width: 2800 mm (9 ft. 2 in.)

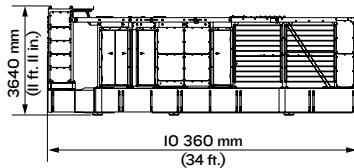

MUFFLERS AND AIR CLEANERS ASSEMBLY

Weight: 1610 kg (3,549 lb.)
Width: 2560 mm (8 ft. 5 in.)

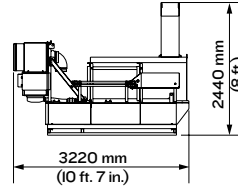

GREASE TANK

Weight: 1200 kg (2,646 lb.)
Width: 1150 mm (3 ft. 9 in.)

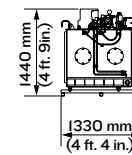

WATER TANK

Weight: 120 kg (265 lb.)
Width: 913 mm (3 ft.)

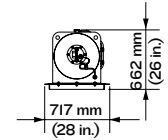

RETURN PIPING ASSEMBLY

Weight: 172 kg (379 lb.)
Width: 400 mm (16 in.)

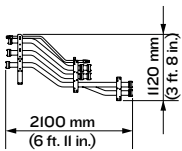

WEIGHT (RIGHT)

Weight: 9950 kg (21,935 lb.)
Width: 610 mm (24 in.)

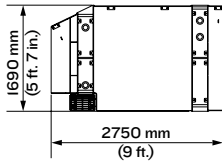

WEIGHT (LEFT)

Weight: 9950 kg (21,935 lb.)
Width: 610 mm (24 in.)

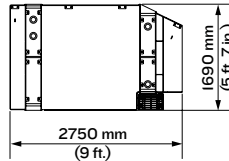

COUNTERWEIGHT (RIGHT)

Weight: 29 500 kg (65,036 lb.)
Width: 1530 mm (5 ft.)

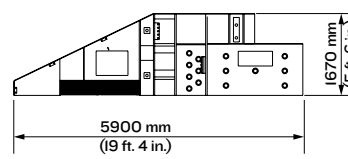

COUNTERWEIGHT (LEFT)

Weight: 29 500 kg (65,036 lb.)
Width: 1520 mm (5 ft.)

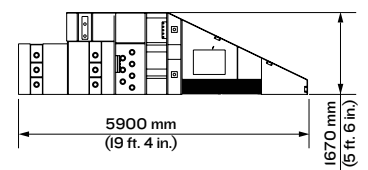

TRANSPORTATION

Upperstructure (continued)		EX8000-6			
Other parts		Dimensions			
Content	Quantity	Length	Width	Height	Weight
Cover	1	1790 mm (5 ft. 10 in.)	485 mm (19 in.)	970 mm (3 ft. 2 in.)	59 kg (130 lb.)
Fender 1	1	3015 mm (9 ft. 11 in.)	1480 mm (4 ft. 10 in.)	1950 mm (6 ft. 5 in.)	695 kg (1,532 lb.)
Fender 2	1	1730 mm (5 ft. 8 in.)	689 mm (27 in.)	2440 mm (8 ft.)	190 kg (419 lb.)
Fender 3	1	1370 mm (4 ft. 6 in.)	478 mm (19 in.)	1950 mm (6 ft. 5 in.)	145 kg (320 lb.)
Fender 4	1	2000 mm (6 ft. 7 in.)	675 mm (27 in.)	1950 mm (6 ft. 5 in.)	301 kg (664 lb.)
Fender 5	1	2470 mm (8 ft. 1 in.)	675 mm (27 in.)	1950 mm (6 ft. 5 in.)	226 kg (498 lb.)
Fender 6	1	2200 mm (7 ft. 3 in.)	682 mm (27 in.)	1950 mm (6 ft. 5 in.)	233 kg (514 lb.)
Fender 7	1	2510 mm (8 ft. 3 in.)	675 mm (27 in.)	2440 mm (8 ft.)	248 kg (547 lb.)
Fender 8	1	2580 mm (8 ft. 6 in.)	677 mm (27 in.)	1950 mm (6 ft. 5 in.)	290 kg (639 lb.)
Handrail 1	1	2030 mm (6 ft. 8 in.)	420 mm (17 in.)	1430 mm (4 ft. 8 in.)	28 kg (62 lb.)
Handrail 2	1	2540 mm (8 ft. 4 in.)	573 mm (23 in.)	1010 mm (3 ft. 4 in.)	71 kg (157 lb.)
Handrail 3	1	2630 mm (8 ft. 8 in.)	247 mm (10 in.)	1310 mm (4 ft. 4 in.)	31 kg (68 lb.)
Handrail 4	1	1430 mm (4 ft. 8 in.)	354 mm (14 in.)	2030 mm (6 ft. 8 in.)	29 kg (64 lb.)
Handrail 5	1	1340 mm (4 ft. 5 in.)	684 mm (27 in.)	992 mm (3 ft. 3 in.)	24 kg (53 lb.)
Handrail 6	1	2540 mm (8 ft. 4 in.)	370 mm (14 in.)	1010 mm (3 ft. 4 in.)	71 kg (157 lb.)
Handrail 7	1	2180 mm (7 ft. 2 in.)	83 mm (3 in.)	1010 mm (3 ft. 4 in.)	28 kg (62 lb.)
Handrail 8	2	2660 mm (8 ft. 9 in.)	266 mm (10 in.)	1010 mm (3 ft. 4 in.)	35/@ kg (77 lb.)
Handrail 9	1	2480 mm (8 ft. 2 in.)	223 mm (9 in.)	1010 mm (3 ft. 4 in.)	30 kg (66 lb.)
Handrail 10	2	2240 mm (7 ft. 4 in.)	283 mm (11 in.)	1010 mm (3 ft. 4 in.)	19/@ kg (42 lb.)
Handrail 11	2	2960 mm (9 ft. 9 in.)	467 mm (18 in.)	1310 mm (4 ft. 4 in.)	27/@ kg (60 lb.)
Step 1	1	392 mm (15 in.)	837 mm (33 in.)	1560 mm (5 ft. 1 in.)	30 kg (66 lb.)
Step 2	1	2240 mm (7 ft. 4 in.)	700 mm (28 in.)	1310 mm (4 ft. 4 in.)	110 kg (243 lb.)
Step 3	1	1450 mm (4 ft. 9 in.)	711 mm (28 in.)	1600 mm (5 ft. 3 in.)	87 kg (192 lb.)
Step 4	1	1120 mm (3 ft. 8 in.)	734 mm (29 in.)	1270 mm (4 ft. 2 in.)	73 kg (161 lb.)
Step 5	1	3100 mm (10 ft. 2 in.)	585 mm (23 in.)	1260 mm (4 ft. 2 in.)	193 kg (425 lb.)
Step 6	1	1130 mm (3 ft. 8 in.)	700 mm (28 in.)	2090 mm (6 ft. 10 in.)	124 kg (273 lb.)
Step 7	1	2340 mm (7 ft. 8 in.)	700 mm (28 in.)	3310 mm (10 ft. 10 in.)	223 kg (492 lb.)
Step 8	1	3180 mm (10 ft. 5 in.)	596 mm (23 in.)	1260 mm (4 ft. 2 in.)	186 kg (410 lb.)
Step 9	1	1440 mm (4 ft. 8 in.)	859 mm (34 in.)	1300 mm (4 ft. 3 in.)	142 kg (313 lb.)
Step 10	1	1610 mm (5 ft. 3 in.)	1230 mm (4 ft.)	1330 mm (4 ft. 4 in.)	118 kg (260 lb.)
Step 11	1	1490 mm (4 ft. 11 in.)	1020 mm (3 ft. 4 in.)	1330 mm (4 ft. 4 in.)	101 kg (223 lb.)
Step 12	1	1320 mm (4 ft. 4 in.)	1410 mm (4 ft. 8 in.)	1310 mm (4 ft. 4 in.)	184 kg (406 lb.)
Step 13	1	1660 mm (5 ft. 5 in.)	672 mm (26 in.)	1310 mm (4 ft. 4 in.)	120 kg (265 lb.)
Step 14	1	635 mm (25 in.)	1030 mm (3 ft. 5 in.)	1310 mm (4 ft. 4 in.)	76 kg (168 lb.)
Step 15	1	990 mm (3 ft. 3 in.)	736 mm (29 in.)	1350 mm (4 ft. 5 in.)	86 kg (190 lb.)
Step 16	1	394 mm (15 in.)	652 mm (26 in.)	1590 mm (5 ft. 3 in.)	61 kg (134 lb.)
Step 17	1	1120 mm (3 ft. 8 in.)	734 mm (29 in.)	1300 mm (4 ft. 3 in.)	73 kg (161 lb.)
Step 18	1	1490 mm (4 ft. 10 in.)	700 mm (28 in.)	1600 mm (5 ft. 3 in.)	87 kg (192 lb.)
Step 19	1	2510 mm (8 ft. 3 in.)	772 mm (30 in.)	1310 mm (4 ft. 4 in.)	127 kg (280 lb.)
Step assembly 1	1	3370 mm (11 ft. 1 in.)	225 mm (9 in.)	1500 mm (4 ft. 11 in.)	294 kg (648 lb.)
Step assembly 2	1	3370 mm (11 ft. 1 in.)	125 mm (5 in.)	683 mm (27 in.)	191 kg (421 lb.)
Ladderbox	1	1650 mm (5 ft. 5 in.)	1750 mm (5 ft. 9 in.)	1900 mm (6 ft. 3 in.)	812 kg (1,790 lb.)
Ladder 1	1	3590 mm (11 ft. 9 in.)	1100 mm (3 ft. 7 in.)	2140 mm (7 ft.)	897 kg (1,978 lb.)
Ladder 2	1	717 mm (28 in.)	265 mm (10 in.)	1790 mm (5 ft. 10 in.)	26 kg (57 lb.)

SPECS

TRANSPORTATION

Undercarriage

EX8000-6

MOTOR COVER STAY

Weight: 161 kg (355 lb.)
Width: 125 mm (5 in.)

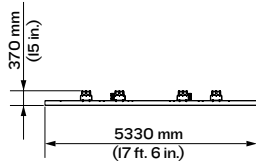

TRACK SIDE FRAMES

Weight: 63 600 kg (140,214 lb.) x 2
Width: 1862 mm (6 ft. 1 in.)

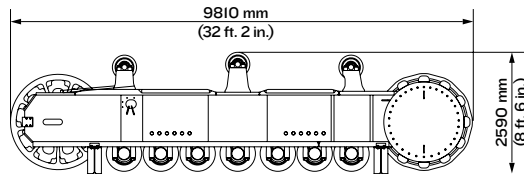

TRACK LINKS

Set A
Weight: 5860 kg (12,919 lb.) x 18
Width: 440 mm (17 in.)

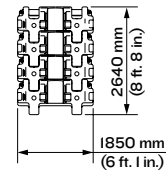

Set B
Weight: 4390 kg (9,678 lb.) x 2
Width: 440 mm (17 in.)

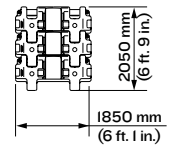

TRAVEL DEVICES

Weight: 10 800 kg (23,810 lb.) x 2
Width: 1970 mm (6 ft. 6 in.)

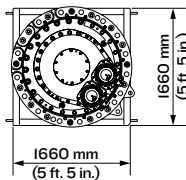

TRACK FRAME ASSEMBLY

Weight: 60 000 kg (132,277 lb.)
Width: 7210 mm (23 ft. 8 in.)

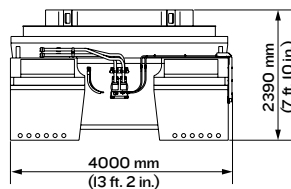

VALVE BRAKES

Weight: 60 kg (132 lb.) x 4
Width: 252 mm (10 in.)

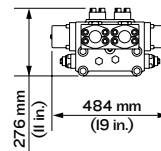

SWING CIRCLE

Weight: 22 000 kg (48,502 lb.)
Width: 4670 mm (15 ft. 4 in.)

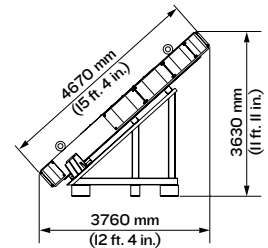

Other parts

Content	Quantity	Length	Width	Dimensions	
				Height	Weight
Cover 1	1	750 mm (30 in.)	511 mm (20 in.)	2380 mm (7 ft. 10 in.)	69 kg (152 lbs.)
Cover 2	2	725 mm (29 in.)	511 mm (20 in.)	2380 mm (7 ft. 10 in.)	66/@ kg (146 lbs.)
Cover 3	1	1045 mm (3 ft. 5 in.)	511 mm (20 in.)	2380 mm (7 ft. 10 in.)	103 kg (227 lbs.)
Cover 4	1	1083 mm (3 ft. 7 in.)	838 mm (33 in.)	2602 mm (8 ft. 6 in.)	138 kg (304 lbs.)
Cover 5	8	205 mm (8 in.)	290 mm (11 in.)	770 mm (30 in.)	24/@ kg (53 lbs.)
Cover 6	8	495 mm (19 in.)	290 mm (11 in.)	505 mm (20 in.)	22/@ kg (49 lbs.)
Cover 7	4	890 mm (35 in.)	61 mm (2 in.)	430 mm (17 in.)	22/@ kg (49 lbs.)
Ladder	1	460 mm (18 in.)	626 mm (25 in.)	2160 mm (7 ft. 1 in.)	26 kg (57 lbs.)
Step	1	410 mm (16 in.)	415 mm (16 in.)	766 mm (30 in.)	35 kg (77 lbs.)

TRANSPORTATION

Loader Attachments

EX8000-6

BOOM ASSEMBLY

Weight: 57 200 kg (126,104 lb.)
Width : 3258 mm (10 ft. 8 in.)

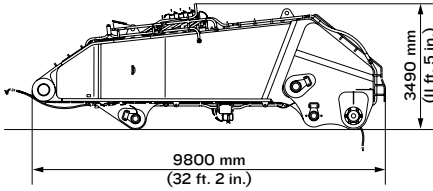

ARM ASSEMBLY

Weight: 31 100 kg (68,564 lb.)
Width: 3650 mm (12 ft.)

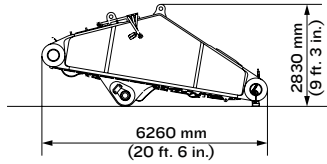

BOOM CYLINDERS

Weight: 9720 kg (21,429 lb.) x 2
Width: 760 mm (30 in.)

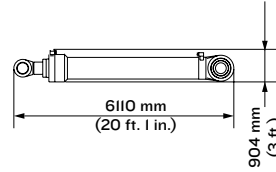

ARM CYLINDERS

Weight: 5020 kg (11,067 lb.) x 2
Width: 725 mm (29 in.)

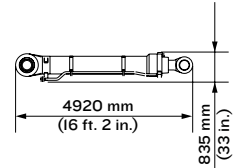

BUCKET CYLINDERS

Weight: 5530 kg (12,192 lb.) x 2
Width: 1070 mm (3 ft. 6 in.)

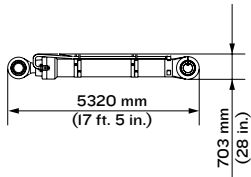

REAR BUCKET ASSEMBLY

Weight: 32 800 kg (72,312 lb.)
Width: 5620 mm (18 ft. 5 in.)

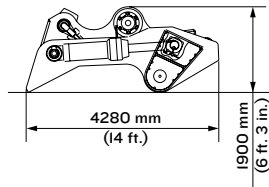

FRONT BUCKET ASSEMBLY WITH SHROUDS

Weight: 26 000 kg (57,320 lb.)
Width: 5630 mm (18 ft. 6 in.)

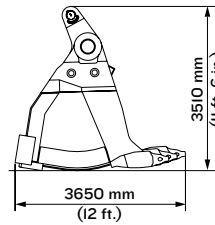

TEETH

Weight: 352 kg (776 lb.) x 6
Width: 430 mm (17 in.)

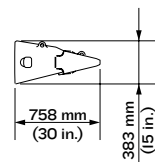

Other parts

Content	Quantity	Dimensions				Weight (kg)
		Length (mm)	Width (mm)	Height (mm)		
Handrail 1	2	1980 mm (6 ft. 6 in.)	426 mm (17 in.)	1010 mm (3 ft. 4 in.)		20/@ kg (44 lbs.)
Handrail 2	2	2850 mm (9 ft. 4 in.)	275 mm (11 in.)	1010 mm (3 ft. 4 in.)		33/@ kg (73 lbs.)

SPECS

TRANSPORTATION

Backhoe Attachments

EX8000-6

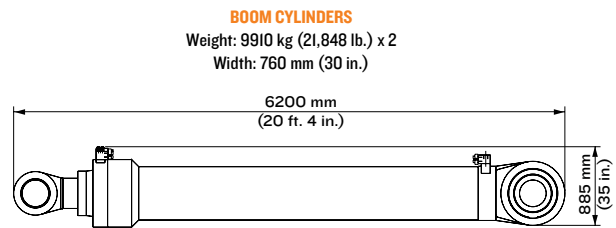
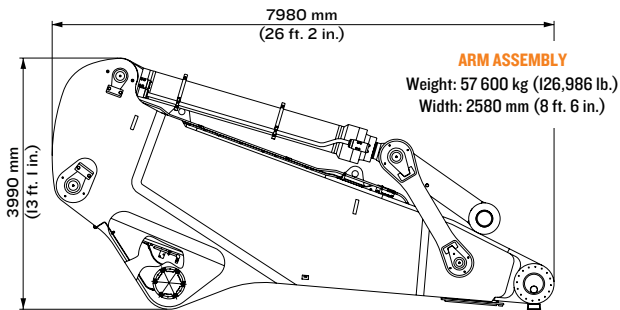
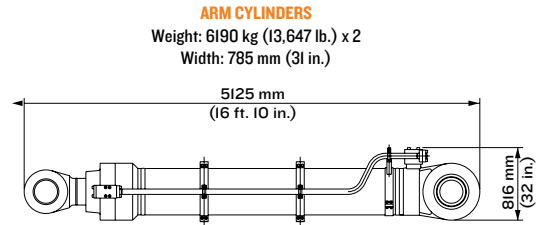
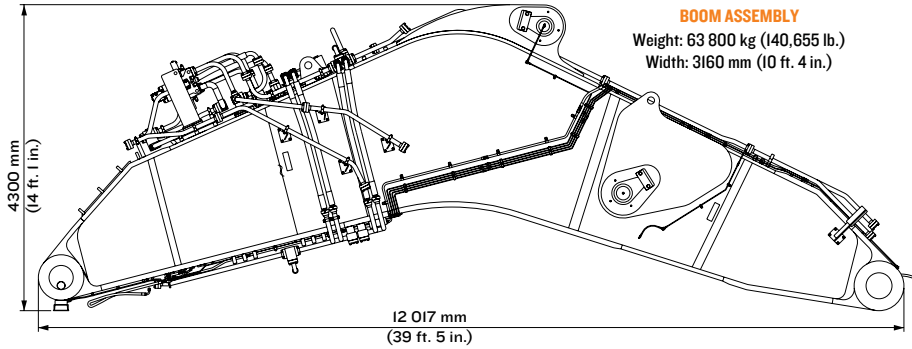

Estimated backhoe bucket dimensions. Hitachi estimates 43.0 m³ bucket in 1800 kg/cm³ material density or less.

LIFTING CAPACITIES

EX8000-6 BE												Unit: 1000 kg (1,000 lb.)		
Load Point Height	12.0 m (39.4 ft.)		14.0 m (45.9 ft.)		16.0 m (52.5 ft.)		18.0 m (59.1 ft.)		20.0 m (65.6 ft.)		At Maximum Reach			
	Over Front	Over Side	Over Front	Over Side	Over Front	Over Side	Over Front	Over Side	Over Front	Over Side	Over Front	Over Side	meters (feet)	
EX8000-6 BE with 11.5-m (37.7 ft.) boom, 5.8-m (19.0 ft.) arm, 43.0-m ³ (56.2 cu. yd.) bucket (SAE) and 1850-mm (6 ft. 1 in.) shoes														
12.0 m (39.4 ft.)							*42.9 (94.6)	*42.9 (94.6)			*24.6 (54.2)	*24.6 (54.2)	21.3 (47.0)	
10.0 m (32.8 ft.)					*53.3 (117.5)	*53.3 (117.5)	*50.8 (112.0)	*50.8 (112.0)			*25.3 (55.8)	*25.3 (55.8)	21.5 (47.4)	
8.0 m (26.2 ft.)			*62.0 (136.7)	*62.0 (136.7)	*61.5 (135.6)	*61.5 (135.6)	*57.2 (126.1)	*57.2 (126.1)			*26.8 (59.1)	*26.8 (59.1)	21.6 (47.6)	
6.0 m (19.7 ft.)			*92.2 (203.3)	*92.2 (203.3)	*77.0 (169.8)	*77.0 (169.8)	*65.9 (145.3)	*65.9 (145.3)	*39.3 (86.6)	*39.3 (86.6)	*29.2 (64.4)	*29.2 (64.4)	21.4 (47.2)	
4.0 m (13.1 ft.)			*119.0 (262.4)	*119.0 (262.4)	*96.5 (212.7)	*96.5 (212.7)	*76.9 (169.5)	*76.9 (169.5)	*43.8 (96.6)	*43.8 (96.6)	*32.7 (72.1)	*32.7 (72.1)	20.9 (46.1)	
2.0 m (6.6 ft.)			*120.0 (264.6)	*120.0 (264.6)	*96.5 (212.7)	*96.5 (212.7)	*78.2 (172.4)	*78.2 (172.4)			*27.5 (60.6)	*27.5 (60.6)	20.2 (44.5)	
Ground Line			*116.0 (255.7)	*116.0 (255.7)	*92.8 (204.6)	*92.8 (204.6)	*73.4 (161.8)	*73.4 (161.8)						
-2.0 m (-6.6 ft.)	*129.0 (284.4)	*129.0 (284.4)	*105.0 (231.5)	*105.0 (231.5)	*83.8 (184.7)	*83.8 (184.7)	*62.9 (138.7)	*62.9 (138.7)						
-4.0 m (-13.1 ft.)	*106.0 (233.7)	*106.0 (233.7)	*87.2 (192.2)	*87.2 (192.2)	*66.8 (147.3)	*66.8 (147.3)								

*Indicates hydraulically limited capacity; numbers without * indicate stability-limited capacities, in kg. The load point is a hook (not standard equipment) loaded on the back of the bucket. Lifting capacity of the EX Series does not exceed 75% of tipping load with the machine on firm, level ground or 87% full hydraulic capacity. Ratings are based on SAE J1097.

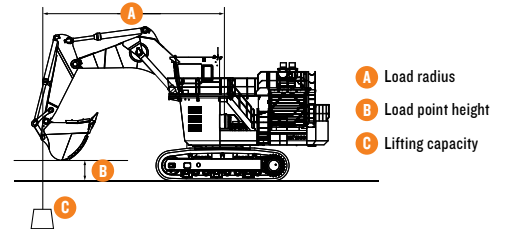

SPECS

STANDARD / OPTIONAL EQUIPMENT

For the EX8000-6 equipped with a diesel engine.

Key: ● Standard ▲ Optional or special kit

8000 Engine

- 140 A alternator
- Heavy-duty-type air cleaner with dust ejector
- Cartridge-type engine oil filter
- Cartridge-type engine oil bypass filter
- Cartridge-type fuel filter
- Water filter
- Fan guard
- Isolation-mounted engine
- Pre-lubrication system
- Auto-idle system
- Emergency engine stop system
- Hydraulic-drive cooling-fan system
- Engine oil reserve system
- Engine room cooling fan
- Radiator reserve tank

Hydraulic System

- Engine-Pump (E-P) control system
- Integrated Optimum Hydraulic System (I-OHS)
- Fuel-saving Pump System (FPS)
- Hydraulic-drive cooling-fan system
- Forced-lubrication and forced-cooling pump drive system
- Control valve with main relief valve
- Suction filter
- Full-flow filter
- Bypass filter
- Pilot filter
- Drain filter
- High-pressure strainer

Undercarriage

- Travel parking brake
- Travel motion alarm device
- Hydraulic track adjuster with N2 gas accumulator and relief valve
- 1850 mm (6 ft. 1 in.) triple grouser shoes
- Single-flange rollers

Upperstructure

- Lockable machine covers
- 80 000-kg (176,370 lb.) counterweight
- Hydraulic-drive grease gun with hose reel
- Swing parking brake
- Electric oil pump to draw hydraulic oil from suction and return pipelines
- Folding stairs with wide steps

Cab

- Top guard, OPG Level II
- All-weather sound-suppressed steel-integrated cab
- Fluid-filled elastic mounts
- Laminated glass windshield
- Reinforced/tinted (green color) glass side windows
- Parallel-link-type intermittent windshield wiper
- Front windshield washer
- Main-display with various meters, pilot indicators and warning indicators
- Air-suspension seat with automatic weight-adjusting function
- Wrist-control-type electric lever with height-adjusting function

8000 Cab (continued)

- Electric travel pedals
- Electric bucket-open/close pedals
- LED-type room lamps
- Footrest
- Air horn with electric compressor
- Auto-tuning AM-FM radio with digital clock
- Seat belt
- Hot and cool box
- Utility space, 1100 mm (3 ft. 7 in.) x 1800 mm (5 ft. 11 in.)
- Floor mat
- Air conditioner with defroster
- Rearview mirror
- Evacuation hammer
- Emergency escape device
- Trainer's seat
- Pilot control shut-off lever

Data Logging System

- Data Logging Unit (DLU) continuously records performance of the engine and the hydraulic system. The record can be downloaded by PC.

Communication system**

- Satellite data-transmitting system
- Wireless Interface Unit (WIU)

Monitor Systems

Meters

- Clock
- Coolant temperature gauge
- Tachometer
- Engine oil pressure gauge
- Engine oil temperature gauge
- Hour meter
- Fuel gauge
- Battery voltage gauge
- Hydraulic oil temperature gauge
- Ambient temperature

Pilot indicators (green)

- Coolant level check
- Engine oil level (oil pan) check
- Engine oil level (reserve tank) check
- Hydraulic oil level check
- Pre-lubrication system
- Auto-lubrication
- Auto-idle
- Travel mode

Warning indicators (red)

- Alternator
- Pump transmission oil level
- Engine stop
- Engine oil pressure
- Coolant overheat
- Coolant level
- Engine overrun
- Fuel temperature
- Exhaust temperature
- Hydraulic oil level
- Auto-lubrication
- Stop valve
- Electric lever
- Emergency engine stop
- Tension

8000 Monitor Systems (continued)

Warning indicators (amber)

- Fast-filling

Warning indicators (yellow)

- Engine oil pressure
- Coolant overheat
- Coolant level
- Fuel temperature
- Engine warning
- Exhaust temperature
- Air cleaner restriction
- Stairway position
- Hydraulic oil overheat
- Pump contamination
- Electrical equipment box

Alarm buzzers

- Pump transmission oil level
- Hydraulic oil level
- Stop valve
- Electric lever
- Fast-filling
- Stairway position
- Overheat
- Engine coolant pressure
- Engine coolant level
- Fuel temperature
- Engine oil pressure
- Engine oil temperature
- Air intake manifold temperature
- Crankcase pressure

Lights

- 12 working lights
- 4 entrance lights
- 12 maintenance lights
- 12 high-brightness working lights

Miscellaneous

- Stairs and handrails (Meet ISO)
- Recirculation air filter for air conditioner
- Ventilation air filter for air conditioner
- 12 V power terminal board
- Stop valve for transport and reassembly
- Lincoln auto-lubrication system for front-attachment pins, swing bearing, and center joint
- Hydraulic oil suction pump
- Fast-filling drop-down panel with Wiggins coupler for fuel, engine oil, engine coolant, grease, pump transmission oil and swing device oil
- Fast-filling couplers
- Camera monitor system
4 cameras and 2 color monitors

Optional Equipment

- ▲ Cold weather package*
- ▲ Travel motor guard
- ▲ Travel device guard
- ▲ 3rd Party Fleet Management Interface Connection Kit
- ▲ Highland application*
- ▲ Upper slider
- ▲ Additional air horn (right side)
- ▲ Standard tool kit

*Engineered on request.

**The availability of the system depends on licensing regulations in each country.

See your Hitachi dealer for further information.

HITACHI

hitachiconstruction.com